

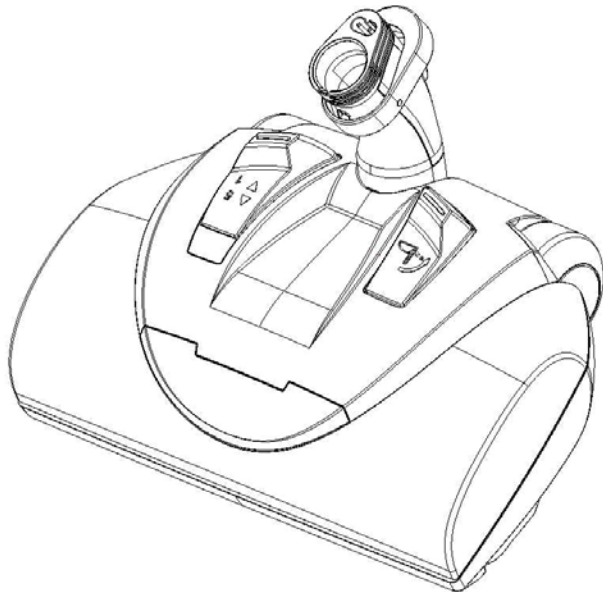

WESSEL-WERK

EBK 360

Electric Power Nozzle



Operating Manual

Wessel-Werk USA
128 Gasoline Alley
Mooresville, NC 28117
www.wessel-werk.com



IMPORTANT SAFEGUARDS

When using an electric appliance, basic precautions should always be followed, including the following:

Read all instructions before using this Motorized Nozzle.

WARNING

To reduce the risk of fire, electric shock or injury:

- Do not use outdoors or on wet surfaces.
- Do not leave nozzle when plugged in. Turn off the switch, place handle in up position and unplug the electric cord when not in use and before servicing. If the nozzle is not working as it should, return it to place of purchase.
- Do not allow to be used as a toy. Close attention is necessary when used by or near children.
- Use only as described in this manual. Use only manufacturer's recommended attachments
- Do not use with damaged cord or plug. If nozzle is not working as it should because it has been dropped, damaged, left outdoors, or dropped into water, return it to a service center before using.
- Do not: pull or carry by cord, use cord as a handle, close a door on cord, or pull cord around sharp edges or corners. Do not run vacuum cleaner over cord. Keep cord away from heated surfaces.
- Do not use extension cords or outlets with inadequate current carrying capacity.
- Turn off all controls before unplugging.
- Do not unplug by pulling cord. To unplug, grasp the plug, not the cord.
- Do not handle plug or nozzle with wet hands.
- Do not put any object into vacuum intake openings. Do not use with any opening blocked. Keep vacuum intake openings free of dust, lint, hair or any anything that may reduce airflow.

- **This nozzle creates suction and contains a revolving brush roll.** Keep hair, loose clothing, fingers and all parts of body away from openings and moving parts.
- Do not place motorized nozzle on furniture or stairs as the brush roll may cause damage. Place nozzle on floor with the handle in storage position while using attachments.
- Do not pick up anything that is burning or smoking such as cigarettes, matches or hot ashes.
- Belt pulleys can become hot during normal use. To prevent burns, avoid touching the belt pulley when servicing the drive belt.
- Use extra care when cleaning on stairs.
- Do not use to pick up flammable or combustible liquids such as gasoline, or use in areas when they may be present.
- Store your nozzle indoors in a cool, dry area.
- Keep your work area well lighted.
- Unplug electrical appliances before vacuuming them.

SAVE THESE INSTRUCTIONS

Operation

Getting Started

- Depress the neck release pedal to place the power nozzle into the operating position (see illustration page 6).
- The power nozzle will start when power is supplied.

Height Adjustment

- Your power nozzle has a 5 setting height adjustment. Setting #1 is the lowest setting. Setting #5 is the highest setting. (see illustration page 6).
- To change the height of the nozzle simply apply pressure to the height adjustment pedal with your toe. (see illustration page 6).
- For best results use the lowest possible height setting. (see illustration page 6).

Cleaning Brush Roll

It may happen that your agitator brush becomes blocked or less effective. This may be caused by excessive hairs and threads wrapped around the brush roller.

- Always unplug the nozzle from the power supply first.

Cleaning the brush roller

- ❑ Insert the points of a pair of scissors under the hair/debris wrapped around the brush roller (see illustration page 7). Move the scissors to catch the threads and hairs in the scissors.
- ❑ Cut the threads of hairs and remove them manually or using a small sized pair of pliers.

Should your nozzle cease to pick-up debris:

This can be caused by an obstruction in the intake and or neck of the power nozzle. This can be caused when excessively large or long debris, like paper, a tooth pick or a sock, is lodged in the intake and/or neck area of the nozzle.

- Always unplug the nozzle from the power supply first.
- **Clearing an Obstruction**
 - ❑ Remove the wand from the nozzle by depressing the button on the nozzle neck and pulling the nozzle and wand apart.
 - ❑ Look into the neck and remove any visible debris.
 - ❑ Look into the intake area of the nozzle and remove any visible debris. (See Illustration Page 7)

- If the nozzle is deemed too 'hard' to push across the carpet move the height adjustment setting up one position and review the ease of operation. Continue this operation one step at a time until the ease of operation is acceptable.
- Note: It is possible to raise the nozzle too high where effective cleaning will cease.

Cleaning

- To achieve the best results when cleaning carpet, slowly pass the power nozzle back and forth over the area to be cleaned.
- To clean hard surfaces simply move the power nozzle over the area to be cleaned set the nozzle to #1 height position, leave the vacuum on and have the power nozzle on or off.
- It is best to avoid cleaning carpet fringes. When it is unavoidable, place the power nozzle over the carpet and pull it toward you over the fringe.

Overload Protection

Your nozzle is equipped with overload protection (circuit breaker). The circuit breaker will activate when the the nozzle consumes more power than planned or an obstruction makes the brush hard to turn. If this occurs:

- ❑ Turn off the vacuum cleaner and disconnect the power supply cord.
- ❑ Remove the object that is preventing the brush from rotating.
- ❑ Please note: 30-60 seconds of cool-down time may be required for the circuit breaker to automatically reset.
- ❑ Reconnect the nozzle and proceed to clean.

Identify Parts

A) Height Adjustment Pedal

B) Quick Disconnect - Locking Pivot Swivel Neck

C) Handle Release Pedal



D) Optional LED Headlight

6

H) 4 Soft Rubber Wheels

J) Sculpted Chevron Brush

K) Height Adjustable wheels



L) Air-Flow Control Blade For Hard Floor Cleaning Dry

M) Vacuum Intake

7

EBK 360

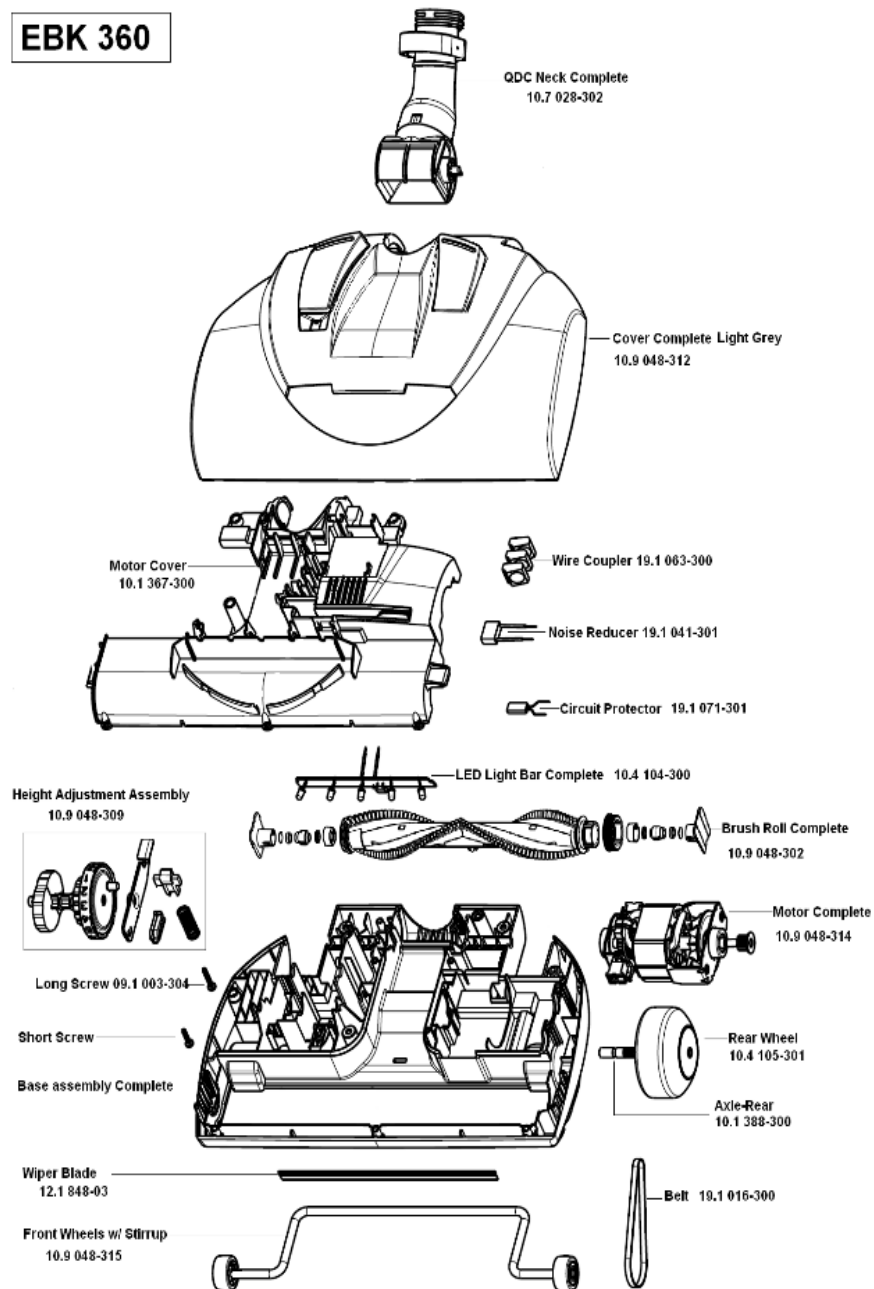

Replacement Parts

Description	Part Number
Cover Complete-Light Grey	10.9 048-312
Cover Complete-Black	10.9 048-318
QDC Neck Complete	10.7 028-302
Brush Roll Complete	10.9 048-302
Height Adjustment Assembly	10.9 048-309
Base Assembly Complete - Black	10.9 048-319
Base Assembly Complete - Light Gray	10.9 048-313
Wiper Blade	12.1 848-06
Motor Complete 120V	10.9 048-314
Front Wheels with Stirrup	10.9 048-315
Wire Coupler	19.1 063-300
Noise Reducer / anti-interference capacitor	19.1 041-301
Circuit Protector	19.1 071-301
LED Light Bar Complete	10.4104-300
Axle - Rear	10.1 388-300
Wheel - Rear	10.4-105-301
Belt - Cogged	19.1 016-300
Motor Cover	10.1 367-300

Also available:

Rating Plate

The model number is indicated on the rating plate which is located on the bottom of the nozzle. For prompt and complete service, always refer to these numbers when contacting your place of purchase.

Model No. **EBK 360**

Date of Purchase: _____



Where Purchased: _____
Company

Address

City

State Zip Code

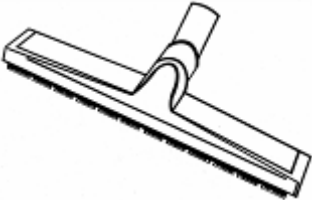
Phone

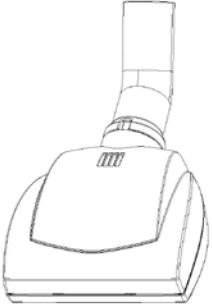
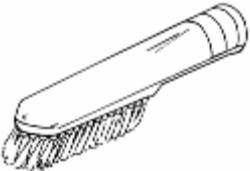
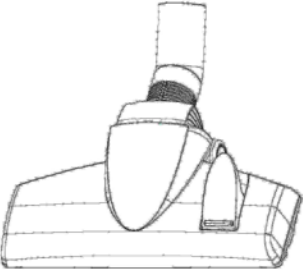
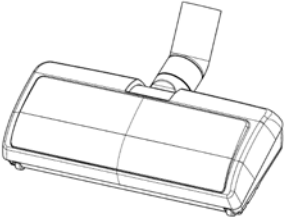
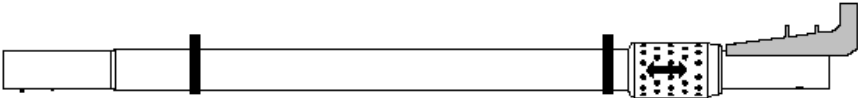
 <p>D 320 –12" and 14" Hardwood Floor Brush</p>	 <p>PT 160 Stair and Upholstery Tool</p>
 <p>HEB 160 Hand Electric Stair and Upholstery Tool</p>	 <p>Universal Elongated Dusting Brush</p>
 <p>RD 264 Combination Carpet/Hard Floor Tool</p>	 <p>EBK 280 Compact Electric Brush</p>
 <p>Telescopic Wand with Cord Management</p>	